

## USER'S MANUAL SMOKE ALARMS



### AC Powered Photo & Ion Smoke Alarm

Input: 120V AC ~, 60Hz, 0.07A

**Model 3120B**  
with Battery Back-Up and Silence

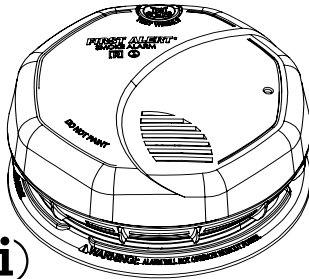

#### IMPORTANT! PLEASE READ CAREFULLY AND SAVE.

This user's manual contains important information about your Smoke Alarm's operation. If you are installing this Smoke Alarm for use by others, you must leave this manual—or a copy of it—with the end user.

LISTED TO  
**UL 217**  
STANDARD Model 3120B

Printed in Mexico  
MO8-0206-008\_WEB 6/19

## INTRODUCTION

Thank you for choosing First Alert® for your Smoke Alarm needs. You have purchased a state of the art Smoke Alarm designed to provide you with an early warning of a fire. Please take the time to read this manual and make this Smoke Alarm an integral part of your family's safety plan.

#### Key Features of the 3120B Photo & Ion Combo Smoke Alarm:

**Photo & Ion Smoke Sensors:** Dual photoelectric and ionization smoke sensing technologies for optimal sensing of smoke particles produced in both flaming and smoldering fires.

**Optipath 360 Technology™:** Patented technology provides 360° of direct access to the smoke sensor.

**Two Silence Features:** **Low Battery Silence** temporarily silences low battery chirp for up to eight hours before replacing low battery. **Alarm Silence** silences an unwanted alarm for several minutes.

**Two Latching Features:** **Alarm Latch** remembers which unit initiated an alarm. **Low Battery Latch** visually identifies which unit is in low battery condition.

**Perfect Mount:** Mounting bracket keeps alarm secure over a wide rotation range to allow for perfect alignment.

**Battery back-up:** Keeps alarm functioning during a power interruption provided batteries are fresh and installed properly.

© 2019 BRK Brands, Inc. All rights reserved. Distributed by BRK Brands, Inc. BRK Brands, Inc. is a subsidiary of Newell Brands Inc. (NASDAQ: NWL) 3901 Liberty Street, Aurora, IL 60504-8122  
Customer Service Team: (800) 323-9005 • www.firstalert.com • www.brkelectronics.com  
06/19 • Printed in Mexico • MO8-0206-008\_WEB

All First Alert® and BRK® Smoke Alarms conform to regulatory requirements, including UL217 and are designed to detect particles of combustion. Smoke particles of varying number and size are produced in all fires.

**i** Ionization technology is generally more sensitive than photoelectric technology at detecting small particles, which tend to be produced in greater amounts by flaming fires, which consume combustible materials rapidly and spread quickly. Sources of these fires may include paper burning in a wastebasket, or a grease fire in the kitchen.

**p** Photoelectric technology is generally more sensitive than ionization technology at detecting large particles, which tend to be produced in greater amounts by smoldering fires, which may smolder for hours before bursting into flame. Sources of these fires may include cigarettes burning in couches or bedding.

For maximum protection, use both types of Smoke Alarms on each level and in every bedroom of your home.

## FIRE SAFETY TIPS

Follow safety rules and prevent hazardous situations: 1) Use smoking materials properly. Never smoke in bed. 2) Keep matches or lighters away from children; 3) Store flammable materials in proper containers; 4) Keep electrical appliances in good condition and don't overload electrical circuits; 5) Keep stoves, barbecue grills, fireplaces and chimneys grease- and debris-free; 6) Never leave anything cooking on the stove unattended; 7) Keep portable heaters and open flames, like candles, away from flammable materials; 8) Don't let rubbish accumulate.

Keep alarms clean, and test them weekly. Replace alarms immediately if they are not working properly. Smoke Alarms that do not work cannot alert you to a fire. Keep at least one working fire extinguisher on every floor, and an additional one in the kitchen. Have fire escape ladders or other reliable means of escape from an upper floor in case stairs are blocked.

## BEFORE YOU INSTALL THIS SMOKE ALARM

**IMPORTANT!** Read "Recommended Locations for Smoke Alarms" and "Locations to Avoid for Smoke Alarms" before beginning. This unit monitors the air, and when smoke reaches its sensing chamber, it alarms. It can give you more time to escape before fire spreads. This unit can ONLY give an early warning of developing fires if it is installed, maintained and located where smoke can reach it, and where all residents can hear it, as described in this manual. This unit will not sense gas, heat, or flame. It cannot prevent or extinguish fires.

#### Understand The Different Type of Smoke Alarms

Battery powered or electrical? Different Smoke Alarms provide different types of protection. See "About Smoke Alarms" for details.

#### Know Where To Install Your Smoke Alarms

Fire Safety Professionals recommend at least one Smoke Alarm on every level of your home, in every bedroom, and in every bedroom hallway or separate sleeping area. See "Recommended Locations For Smoke Alarms" and "Locations To Avoid For Smoke Alarms" for details.

#### Know What Smoke Alarms Can and Can't Do

A Smoke Alarm can help alert you to fire, giving you precious time to escape. It can only sound an alarm once smoke reaches the sensor. See "Limitations of Smoke Alarms" for details.

#### Check Your Local Building Codes

This Smoke Alarm is designed to be used in a typical single-family home. It alone will not meet requirements for boarding houses, apartment buildings, hotels or motels. See "Special Compliance Considerations" for details.

### ⚠ DANGER!

**ELECTRICAL SHOCK HAZARD.** Turn off the power to the area where the Smoke Alarm is installed before removing it from the mounting bracket. Failure to turn off the power first may result in serious electrical shock, injury or death.

### ⚠ WARNING!

- This unit will not alert hearing impaired residents. It is recommended that you install special units which use devices like flashing strobe lights to alert hearing impaired residents.
- Installation of this unit must conform to the electrical codes in your area; Articles 210 and 300.3 (B) of NFPA 70 (NEC), NFPA 72, NFPA 101; SBC (SBCCI); UBC (ICBO); NBC (BOCA); OTFDC (CABO), and any other local or building codes that may apply. Wiring and installation must be performed by a licensed electrician. Failure to follow these guidelines may result in injury or property damage.
- This unit must be powered by a 24-hour, 120VAC pure sine wave 60Hz circuit. Be sure the circuit cannot be turned off by a switch, dimmer, or ground fault circuit interrupter. Failure to connect this unit to a 24-hour circuit may prevent it from providing constant protection.
- This Smoke Alarm must have AC or battery power to operate. If the AC power fails, battery back-up will allow the alarm to sound for at least 4 minutes. If AC power fails and the battery is weak, protection should last for at least 7 days. If AC power fails and the battery is dead or missing, the alarm cannot operate.
- Never disconnect the power from an AC powered unit to stop an unwanted alarm. Doing so will disable the unit and remove your protection. In the case of a true unwanted alarm open a window or fan the smoke away from the unit. The alarm will reset automatically when it returns to normal operation. Never remove the batteries from a battery operated unit to stop an unwanted alarm (caused by cooking smoke, etc.). Instead open a window or fan the smoke away from the unit. The alarm will reset automatically.

### ⚠ CAUTION!

- Connect this unit ONLY to other compatible units. See "How To Install This Smoke Alarm" for details. Do not connect it to any other type of alarm or auxiliary device. Connecting anything else to this unit may damage it or prevent it from operating properly.
- This Smoke Alarm has a battery drawer which resists closing unless a battery is installed. This warns you the unit will not operate under DC power without a battery.
- Do not stand too close to the unit when the alarm is sounding. It is loud to wake you in an emergency. Exposure to the horn at close range may harm your hearing.
- Do not paint over the unit. Paint may clog the openings to the sensing chambers and prevent the unit from operating properly.

## HOW TO INSTALL THIS SMOKE ALARM

This Smoke Alarm is designed to be mounted on any standard wiring junction box up to a 4-inch (10 cm) size, on either the ceiling or wall (if allowed by local codes). Read "Recommended Locations For Smoke Alarms" and "Locations to Avoid For Smoke Alarms" before you begin installation.

**Tools you will need:** • Needle-nose pliers or utility knife • Standard Flathead screwdriver.

### ⚠ WARNING!

**Make sure the Alarm is not receiving excessively noisy power. Examples of noisy power could be major appliances on the same circuit, power from a generator or solar power, light dimmer on the same circuit or mounted near fluorescent lighting. Excessively noisy power may cause damage to your Alarm.**

### THE PARTS OF THIS SMOKE ALARM

#### The Mounting Bracket:

To remove the mounting bracket from the Smoke Alarm base, hold the Smoke Alarm base firmly and twist the mounting bracket counterclockwise. The mounting bracket installs onto the junction box. It has a variety of screw slots to fit most boxes.

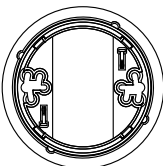

#### The Power Connector:

The power connector plugs into a power input block on the Smoke Alarm. It supplies the unit with AC power.

- The black wire is "hot."
- The white wire is neutral.
- The orange wire is used for interconnect.

**If you need to remove the power connector, turn POWER OFF first.** Insert a flat screwdriver blade between the power connector and the security tab inside the power input block. Gently pry back the tab and pull the connector free.

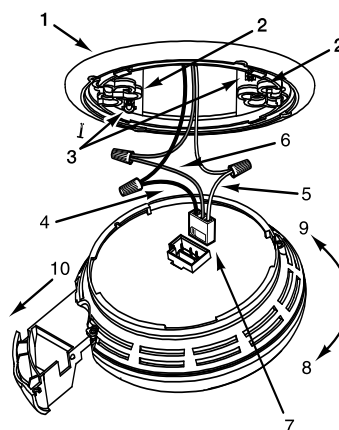
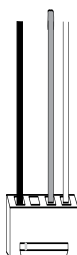

#### The Parts of This Unit

1	Mounting Bracket
2	Mounting Slots
3	Locking Pins (break out of bracket)
4	Hot (Black) AC Wire
5	Neutral (White) AC Wire
6	Interconnect (Orange) Wire
7	Quick-Connect Power Connector
8	Turn this way to remove from bracket
9	Turn this way to attach to bracket
10	Slide-Out Battery Drawer

### FOLLOW THESE INSTALLATION STEPS

The basic installation of this Smoke Alarm is similar whether you want to install one Smoke Alarm, or interconnect more than one Smoke Alarm. If you are interconnecting more than one Smoke Alarm, you **MUST** read "Special Requirements For Interconnected Smoke Alarms" below before you begin installation.

### ⚠ DANGER!

**ELECTRICAL SHOCK HAZARD. Turn off power to the area where you will install this unit at the circuit breaker or fuse box before beginning installation. Failure to turn off the power before installation may result in serious electrical shock, injury or death.**

1. Remove the mounting bracket from the base, and attach it to the junction box.  
Activate the battery back-up by removing the "Pull to Activate Battery Back-Up" tab. Or, install battery back-up. Battery back-up cannot work until you install the battery in the correct position (Match "+" to "+" and "-" to "-").  
Push and hold Test button until the alarm sounds: 3 beeps, pause, 3 beeps, pause. LED flashes once every second.
2. Using wire nuts, connect the power connector to the household wiring.

#### STAND-ALONE ALARM ONLY:

- Connect the white wire on the power connector to the neutral wire in the junction box.
- Connect the black wire on the power connector to the hot wire in the junction box.
- Tuck the orange wire inside the junction box. It is used for interconnect only.

#### INTERCONNECTED UNITS ONLY:

**Strip off about 1/2" (12 mm) of the plastic coating on the orange wire on the power connector.**

- Connect the white wire on the power connector to the neutral wire in the junction box.
- Connect the black wire on the power connector to the hot wire in the junction box.
- Connect the orange wire on the power connector to the interconnect wire in the junction box. Repeat for each unit you are interconnecting. Never connect the hot or neutral wires in the junction box to the orange interconnect wire. Never cross hot and neutral wires between Alarms.

3. Plug the power connector into the back of the Smoke Alarm.
4. Position the base of the Smoke Alarm over the mounting bracket and turn. The Alarm can be positioned over the bracket every 90°. Turn the Smoke Alarm clockwise (right) until the unit is in place.
5. Check all connections.

### ⚠ WARNING!

**Improper wiring of the power connector or the wiring leading to the power connector will cause damage to the Alarm and may lead to a non-functioning Alarm.**

#### STAND-ALONE ALARM ONLY:

- If you are only installing one Smoke Alarm, restore power to the junction box.

#### INTERCONNECTED UNITS ONLY:

- If you are interconnecting multiple Smoke Alarms, repeat steps 1-5 for each Smoke Alarm in the series. When you are finished, restore power to the junction box.

### ⚠ DANGER!

**ELECTRICAL SHOCK HAZARD. Do not restore power until all Smoke Alarms are completely installed. Restoring power before installation is complete may result in serious electrical shock, injury or death.**

6. Make sure the Smoke Alarm is receiving AC power. Under normal operation, the Green power indicator light will shine continuously.
7. If the Green power indicator light does not light, **TURN OFF POWER TO THE JUNCTION BOX** and recheck all connections. If all connections are correct and the Green power indicator still does not light when you restore the power, the unit should be replaced immediately.
8. Test each Smoke Alarm. Press and hold the Test/Silence button until the unit alarms. **When testing a series of interconnected units you must test each unit individually. Make sure all units alarm when each one is tested.**

### ⚠ DANGER!

If any unit in the series does not alarm, **TURN OFF POWER** and recheck connections. If it does not alarm when you restore power, replace it immediately.

### Special Requirements For Interconnected Smoke Alarms

#### ⚠ WARNING!

- Failure to meet any of the above requirements could damage the units and cause them to malfunction, removing your protection.
- AC and AC/DC Smoke Alarms can be interconnected. Under AC power, all units will alarm when one senses smoke. When power is interrupted, only the AC/DC units in the series will continue to send and receive signals. AC powered Smoke Alarms will not operate.

Interconnected units can provide earlier warning of fire than stand-alone units, especially if a fire starts in a remote area of the dwelling. If any unit in the series senses smoke, all units will alarm. To determine which Smoke Alarm initiated an alarm, see table:

#### During an Alarm:

On Initiating Alarm(s)	Red LED(s) flashes (flash) rapidly
On All Other Alarms	Red LED is Off

#### After an Alarm (Latching):

On Initiating Alarm(s)	Red LED(s) flash 3 times, spaced one second apart. The pattern repeats approximately every 45 seconds.
On All Other Alarms	Green LED(s) On, Red LED(s) Off

## IMPORTANT!

Interconnect units within a single family residence only. Otherwise all households will experience unwanted alarms when you test any unit in the series. Interconnected units will only work if they are wired to compatible units and all requirements are met. This unit is designed to be compatible with: **First Alert® Smoke Alarm Models** SA4120, SA4121B, SA100B, SA520 and **BRK® Smoke Alarm Models** 3120B, 9120, 9120B, SC6120B, SC9120B, 7010, 7010B, 7010BSL, 7020B, SC7010B, SC7010BV, 100S, 4120, 4120B, 4120SB; **BRK® CO Alarm Models** CO5120BN, CO5120PDBN; **BRK® Heat Alarm Models** HD6135F and HD6135FB; **BRK® Auxiliary Devices Models** RM3 and RM4 (Relay Modules), SL177 (Strobe Light). See [www.brkelectronics.com](http://www.brkelectronics.com) for most current interconnect list.

### Interconnected units must meet ALL of the following requirements:

- A maximum of 18 compatible units may be interconnected (Maximum of 12 Smoke Alarms).
- The same fuse or circuit breaker must power all interconnected units.
- The total length of wire interconnecting the units should be less than 1000 feet (300 meters). This type of wire is commonly available at Hardware and Electrical Supply stores.
- All wiring must conform to all local electrical codes and NFPA 70 (NEC). Refer to NFPA 72, NFPA 101, and/or your local building code for further connection requirements.

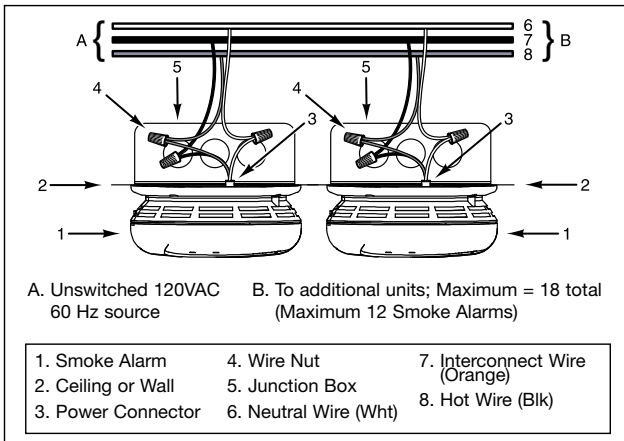

## WEEKLY TESTING

### ⚠ WARNING!

- **NEVER use an open flame of any kind to test this unit. You might accidentally damage or set fire to the unit or to your home. The built-in test switch accurately tests the unit's operation as required by Underwriters Laboratories, Inc. (UL).**
- **If the Alarm ever fails to test properly, replace it immediately. Products under warranty may be returned to the manufacturer for replacement. See "Limited Warranty" at the end of this manual.**

### ⚠ CAUTION!

**DO NOT stand close to the Alarm when the horn is sounding. Exposure at close range may be harmful to your hearing. When testing, step away when horn starts sounding.**

**It is important to test this unit every week to make sure it is working properly. Using the test button is the recommended way to test this Smoke Alarm.**

Press and hold the Test/Silence button on the cover of the unit until the alarm sounds (the unit may continue to alarm for a few seconds after you release the button). If it does not alarm, make sure the unit is receiving power and test it again. If it still does not alarm, replace it immediately.

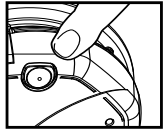

**During testing, you will hear a loud, repeating horn pattern: 3 beeps, pause, 3 beeps, pause. LED flashes once every second.**

When testing a series of interconnected units you must test each unit individually. Make sure all units alarm when each one is tested.

## REGULAR MAINTENANCE

### ⚠ WARNING!

**Use only the replacement batteries listed below. The unit may not operate properly with other batteries. Never use rechargeable batteries since they may not provide a constant charge.**

This unit has been designed to be as maintenance-free as possible, but there are a few simple things you must do to keep it working properly:

- Test it at least once a week.
- Clean the Smoke Alarm at least once a month; gently vacuum the outside of the Smoke Alarm using your household vacuum's soft brush attachment. Test the Smoke Alarm. Never use water, cleaners or solvents since they may damage the unit.
- If the Smoke Alarm becomes contaminated by excessive dirt, dust and/or grime, and cannot be cleaned to avoid unwanted alarms, replace the unit immediately.
- Relocate the unit if it sounds frequent unwanted alarms. See "Locations To Avoid For Smoke Alarms" for details.
- When the battery back-up becomes weak, the Smoke Alarm will "chirp" about once a minute (the low battery warning). This warning should last 7 days, but you should replace the batteries immediately to continue your protection.

### Choosing a replacement battery:

Your Smoke/CO Alarm requires two "AA" Energizer E91 batteries. **These batteries are available at many local retail stores.**

### IMPORTANT!

Actual battery service life depends on the Alarm and the environment in which it is installed. All the batteries specified above are acceptable replacement batteries for this unit. Regardless of the manufacturer's suggested battery life, **you MUST replace the battery immediately once the unit starts "chirping" (the "low battery warning").**

### To replace the batteries (without removing Alarm from the ceiling or wall):

1. Open the battery compartment.
2. Press tabs A and B as shown in the diagram and remove each battery.
3. Insert the new batteries, making sure they snap completely into the battery compartment. Match the terminals on the ends of the batteries with the terminals on the unit.
4. Close the battery compartment, and then test the unit by pressing the Test/Silence button.

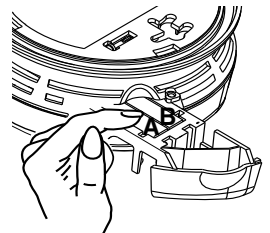

## UNDERSTANDING THE INDICATOR LIGHTS AND ALARM HORN PATTERNS

	AC Power	DC Power
<b>Normal Operation</b>	Constant Green LED No Audible Alarm	Flashing Green LED once/minute No Audible Alarm
<b>Test Condition</b>	Rapidly Flashing Red LED Audible Alarm	Rapidly Flashing Red LED Audible Alarm
<b>Alarm Condition* (Initiating Unit)</b>	Rapidly Flashing Red LED Audible Alarm	Rapidly Flashing Red LED Audible Alarm
<b>Alarm Condition* (Remote Units)</b>	Constant Green LED Audible Alarm	Green LED Off Audible Alarm
<b>Silence Mode</b>	Rapidly Flashing Red LED Audible Alarm Off	Rapidly Flashing Red LED Audible Alarm Off
<b>Low Battery</b>	Alarm "chirp" approx. once/minute	Alarm "chirp" approx. once/minute
<b>Latching Alarm</b>	Red LED flashing 2 seconds on, 2 seconds off	Not available
<b>Low Battery Latch</b>	Green LED flashing 2 seconds on, 2 seconds off	Not available

### NOTE: When power is applied, unit(s) may alarm momentarily.

\*When any Smoke Alarm in an interconnected series triggers an alarm, its red LED will flash rapidly. The red LEDs will remain OFF on any remaining alarms in the series. This feature helps responders identify which unit(s) triggered the alarm.

## OPTIONAL LOCKING FEATURES

The locking features are designed to discourage unauthorized removal of the batteries or Alarm. It is not necessary to activate the locks in single-family households where unauthorized battery or Alarm removal is not a concern.

These Smoke Alarms have two separate locking features: one to lock the battery compartment, and the other to lock the Smoke Alarm to the mounting bracket. You can choose to use either feature independently, or use them both.

**Tools you will need:** • Needle-nose pliers or utility knife • Standard Flathead screwdriver.

Both locking features use locking pins, which are molded into the mounting bracket. Using needle-nose pliers or a utility knife, remove one or both pins from the mounting bracket, depending on how many locking features you want to use.

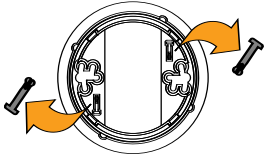

### IMPORTANT!

To permanently remove either lock, insert a flathead screwdriver between the locking pin and the lock, and pry the pin out of the lock.

### TO LOCK THE BATTERY COMPARTMENT

Do not lock the battery compartment until you have installed the batteries and tested the battery back-up.

1. Push and hold Test button until the alarm sounds: 3 beeps, pause, 3 beeps, pause. LED flashes once every second.

### IMPORTANT!

If the unit does not alarm during testing, DO NOT lock the battery compartment! Install new batteries and test again. If the Smoke Alarm still does not alarm, replace it immediately.

2. Using needle-nose pliers or a utility knife, detach one locking pin from the mounting bracket.

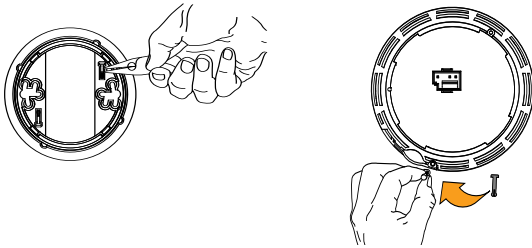

3. Push the locking pin through the hole near the battery drawer on the back of the Smoke Alarm.

### TO UNLOCK THE BATTERY COMPARTMENT

#### IMPORTANT!

Once the Smoke Alarm is installed, you must disconnect it from the AC power before unlocking the battery compartment.

#### ⚠ DANGER!

**ELECTRICAL SHOCK HAZARD.** Turn off the power to the area where the Smoke Alarm is installed before removing it from the mounting bracket. Failure to turn off the power first may result in serious electrical shock, injury or death.

#### ⚠ WARNING!

Always discharge the branch circuit before servicing an AC or AC/DC Smoke Alarm. First, turn off the AC power at the circuit breaker or fuse box. Next, remove the batteries from Smoke Alarms with battery back-up. Finally, press and hold the Test/Silence button for 5-10 seconds to discharge the branch circuit.

1. Remove the Smoke Alarm from the mounting bracket. If the unit is locked to the bracket, see the section "To Unlock the Mounting Bracket."
2. Disconnect the power connector by gently prying it away from the back of the Smoke Alarm.
3. Insert a flathead screwdriver under the head of the locking pin, and gently pry it out of the battery compartment lock. (If you plan to relock the battery compartment, save the locking pin.)
4. To relock the battery compartment, close the battery door and reinsert locking pin in lock.
5. Reconnect the power connector to the back of the Smoke Alarm, reattach the Smoke Alarm to the mounting bracket, and restore the power.

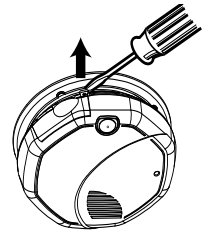

#### IMPORTANT!

When replacing the batteries, always test the Smoke Alarm before relocking the battery compartment.

### TO LOCK THE MOUNTING BRACKET

1. Using needle-nose pliers, detach one locking pin from mounting bracket.

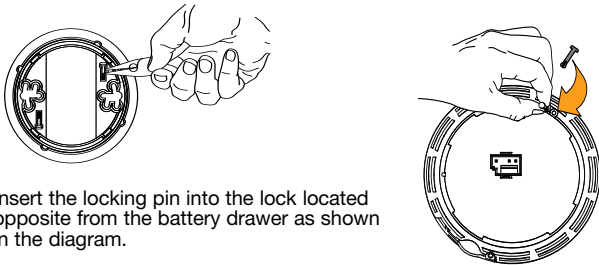

2. Insert the locking pin into the lock located opposite from the battery drawer as shown in the diagram.
3. When you attach the Smoke Alarm to the mounting bracket, the locking pin's head will fit into a notch on the bracket.

### TO UNLOCK THE MOUNTING BRACKET

#### ⚠ DANGER!

**ELECTRICAL SHOCK HAZARD.** Turn off the power to the area where the Smoke Alarm is installed before removing it from the mounting bracket. Failure to turn off the power first may result in serious electrical shock, injury or death.

#### ⚠ WARNING!

Always discharge the branch circuit before servicing an AC or AC/DC Smoke Alarm. First, turn off the AC power at the circuit breaker or fuse box. Next, remove the batteries from Smoke Alarms with battery back-up. Finally, press and hold the Test/Silence button for 5-10 seconds to discharge the branch circuit.

1. Insert a flathead screwdriver between the mounting bracket pin and the mounting bracket.
2. Pry the Smoke Alarm away from the bracket by turning both the screwdriver and the Smoke Alarm counterclockwise (left) at the same time.

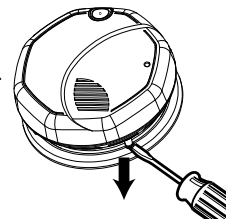

## WEEKLY TESTING

### ⚠ WARNING!

- **NEVER** use an open flame of any kind to test this unit. You might accidentally damage or set fire to the unit or to your home. The built-in test switch accurately tests the unit's operation as required by Underwriters Laboratories, Inc. (UL).
- If the Alarm ever fails to test properly, replace it immediately. Products under warranty may be returned to the manufacturer for replacement. See "Limited Warranty" at the end of this manual.

### ⚠ CAUTION!

DO NOT stand close to the Alarm when the horn is sounding. Exposure at close range may be harmful to your hearing. When testing, step away when horn starts sounding.

It is important to test this unit every week to make sure it is working properly. Using the test button is the recommended way to test this Smoke Alarm.

Press and hold the Test/Silence button on the cover of the unit until the alarm sounds (the unit may continue to alarm for a few seconds after you release the button). If it does not alarm, make sure the unit is receiving power and test it again. If it still does not alarm, replace it immediately.

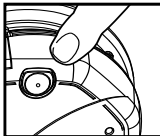

During testing, you will hear a loud, repeating horn pattern: 3 beeps, pause, 3 beeps, pause. LED flashes once every second.

When testing a series of interconnected units you must test each unit individually. Make sure all units alarm when each one is tested.

## REGULAR MAINTENANCE

### ⚠ WARNING!

Use only the replacement batteries listed below. The unit may not operate properly with other batteries. Never use rechargeable batteries since they may not provide a constant charge.

This unit has been designed to be as maintenance-free as possible, but there are a few simple things you must do to keep it working properly:

- Test it at least once a week.
- Clean the Smoke Alarm at least once a month; gently vacuum the outside of the Smoke Alarm using your household vacuum's soft brush attachment. Test the Smoke Alarm. Never use water, cleaners or solvents since they may damage the unit.
- If the Smoke Alarm becomes contaminated by excessive dirt, dust and/or grime, and cannot be cleaned to avoid unwanted alarms, replace the unit immediately.
- Relocate the unit if it sounds frequent unwanted alarms. See "Locations To Avoid For Smoke Alarms" for details.
- When the battery back-up becomes weak, the Smoke Alarm will "chirp" about once a minute (the low battery warning). This warning should last 7 days, but you should replace the batteries immediately to continue your protection.

### Choosing a replacement battery:

Your Smoke/CO Alarm requires two "AA" Energizer E91 batteries. These batteries are available at many local retail stores.

### IMPORTANT!

Actual battery service life depends on the Alarm and the environment in which it is installed. All the batteries specified above are acceptable replacement batteries for this unit. Regardless of the manufacturer's suggested battery life, you **MUST** replace the battery immediately once the unit starts "chirping" (the "low battery warning").

### To replace the batteries (without removing Alarm from the ceiling or wall):

1. Open the battery compartment.
2. Press tabs A and B as shown in the diagram and remove each battery.
3. Insert the new batteries, making sure they snap completely into the battery compartment. Match the terminals on the ends of the batteries with the terminals on the unit.
4. Close the battery compartment, and then test the unit by pressing the Test/Silence button.

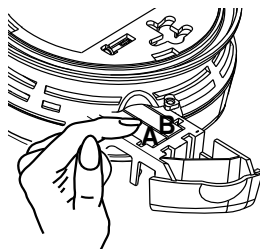

## IF THIS SMOKE ALARM SOUNDS RESPONDING TO AN ALARM

During an alarm, you will hear a loud, repeating horn pattern: 3 beeps, pause, 3 beeps, pause.

### ⚠ WARNING!

- If the unit alarms and you are not testing the unit, it is warning you of a potentially dangerous situation that requires your immediate attention. **NEVER** ignore any alarm. Ignoring the alarm may result in injury or death.
- Never disconnect the AC power to quiet an unwanted alarm. Disconnecting the power disables the Alarm so it cannot sense smoke. This will remove your protection. Instead, open a window or fan the smoke away from the unit. The Alarm will reset automatically.
- If the unit alarms get everyone out of the house immediately.

### ⚠ DANGER!

- **ELECTRICAL SHOCK HAZARD:** Attempting to disconnect the power connector from the unit when the power is on may result in electrical shock, serious injury or death.

When an interconnected system of AC powered units is in alarm, the alarm indicator light on the unit(s) that initiated the alarm will blink rapidly. It will remain OFF on any remaining units.

If the unit alarms, get everyone out of the dwelling immediately.

If the unit alarms and you are certain that the source of smoke is not a fire—cooking smoke or an extremely dusty furnace, for example—open a nearby window or door and fan the smoke away from the unit (Use the Silence Feature to silence the Alarm). This will silence the alarm, and once the smoke clears the unit will reset itself automatically.

## WHAT TO DO IN CASE OF FIRE

- Don't panic; stay calm. Follow your family escape plan.
- Get out of the house as quickly as possible. Don't stop to get dressed or collect anything.
- Feel doors with the back of your hand before opening them. If a door is cool, open it slowly. Don't open a hot door. Keep doors and windows closed, unless you must escape through them.
- Cover your nose and mouth with a cloth (preferably damp). Take short, shallow breaths.
- Meet at your planned meeting place outside your home, and do a head count to make sure everybody got out safely.
- Call the Fire Department as soon as possible from outside. Give your address, then your name.
- Never go back inside a burning building for any reason.
- Contact your Fire Department for ideas on making your home safer.

### ⚠ WARNING!

Alarms have various limitations. See "Limitations of Smoke Alarms" for details.

## USING THE SILENCE FEATURE

The Silence Feature can temporarily quiet an unwanted alarm for up to 15 minutes.

### ⚠ WARNING!

The Silence Feature does not disable the unit—it makes it temporarily less sensitive to smoke. For your safety, if smoke around the unit is dense enough to suggest a potentially dangerous situation, the unit will stay in alarm or may re-alarm quickly. If you do not know the source of the smoke, do not assume it is an unwanted alarm. Not responding to an alarm can result in property loss, injury, or death.

### To silence Smoke Alarms in an interconnected series:

1. To silence multiple alarms in an interconnected series, you must press the Test/Silence button on the unit(s) that triggered the alarm.
2. Once you activate the Silence feature, the Red LED will flash approximately once every 10 seconds.
3. Pressing the Test/Silence button when in silence will restart the silence timer.

### IMPORTANT!

The Silence Feature on these units can temporarily quiet an unwanted alarm for up to 15 minutes. To use this feature, press the Test/Silence button on the cover. **If the unit will not silence and no heavy smoke is present, or if it stays in silence mode continuously, it should be replaced immediately.**

## SILENCING THE LOW BATTERY WARNING

This Silence Feature can temporarily quiet the low battery warning "chirp" for up to 8 hours. Press the Test/Silence button on the Alarm cover until you hear the acknowledge "chirp".

Once the low battery warning "chirp" silence feature is activated, the unit continues to flash the green light once a minute for approximately 8 hours. After 8 hours, the low battery "chirp" will resume. The Alarm will continue to operate as long as AC power is supplied. However, **replace the batteries as soon as possible**, to maintain protection in event of a power outage.

### To silence Alarms in an interconnected series:

To silence an interconnected series of Smoke/CO Alarms, you must press the Test/Silence button on the initiating alarm (The unit with the flashing red light; the red light will be off on all other Alarms.). If you press the Test/Silence on any other Alarm, it will only silence that unit, not the whole interconnected series.

### LATCHING FEATURE

**Alarm Latch** is activated after an Alarm is exposed to alarm levels of smoke. This feature will only work with AC power. After smoke levels drop below alarm levels, the **Red LED** will begin flashing 2 seconds on, 2 seconds off unless reset by test/silence button.

This feature helps emergency responders, investigators, or service technicians identify which unit(s) in your home were exposed to alarm levels of smoke. This can help investigators pinpoint the source of smoke.

**Interconnected Alarms.** Latching Alarm Indicator shows which Alarm(s) in the series were exposed to alarm levels of smoke. The Latching Alarm Indicator stays ON until you clear it, so it can alert you to an alarm that occurred while you were away from home, even though smoke present in the air has dropped below alarm levels.

**Low Battery Latch** is activated when the Alarm is in the "low battery condition". When this occurs, the **Green LED** flashes 2 seconds on, 2 seconds off. This feature is designed to help you identify which Alarm needs to have the battery replaced. Although, the Alarm will sound the low battery chirp approximately once every minute, sometimes during the initial stages of "low battery", the Alarm will chirp in greater intervals than one minute, sometimes up to several hours, until the battery reaches a steady low battery level. This innovative feature eliminates the frustration of waiting for and/or identifying which unit is chirping.

### "SMART INTERCONNECT" FEATURE

This Alarm includes "Smart Interconnect" which enables the Alarm to be interconnected with other First Alert® and BRK Smoke, Heat, and "Smart Interconnect" Smoke, Smoke/CO and CO Alarms. When smoke is detected, all Alarms will sound the smoke horn pattern. When CO is detected, "Smart Interconnect" Alarms will sound the CO horn pattern. Alarms that do not have the "Smart Interconnect" feature will remain silent during a CO alarm.

### IF YOU SUSPECT A PROBLEM

Smoke Alarms may not operate properly because of dead, missing or weak batteries, a build-up of dirt, dust or grease on the Smoke Alarm cover, or installation in an improper location. Clean the Smoke Alarm as described in "Regular Maintenance," and install fresh batteries, then test the Smoke Alarm again. If it fails to test properly when you use the test button, or if the problem persists, replace the Smoke Alarm immediately.

- If you hear a "chirp" approximately once a minute, replace the batteries.
- If you experience frequent non-emergency alarms (like those caused by cooking smoke), try relocating the Smoke Alarm.
- If the alarm sounds when no smoke is visible, try cleaning or relocating the Smoke Alarm. The cover may be dirty.
- If the alarm does not sound during testing, make sure it is receiving AC power from the household current.

### ⚠WARNING!

**Always discharge the branch circuit before servicing an AC or AC/DC Smoke Alarm. First, turn off the AC power at the circuit breaker or fuse box. Next, remove the batteries from Smoke Alarms with battery back-up. Finally, press and hold the test button for 5-10 seconds to discharge the branch circuit.**

**Do not try fixing the alarm yourself – this will void your warranty!**

If the Smoke Alarm is still not operating properly, and it is still under warranty, please see "How to Obtain Warranty Service" in the Limited Warranty.

### RECOMMENDED LOCATIONS FOR SMOKE ALARMS

#### Installing Smoke Alarms in Single-Family Residences

The National Fire Protection Association (NFPA), recommends one Smoke Alarm on every floor, in every sleeping area, and in every bedroom. In new construction, the Smoke Alarms must be AC powered and interconnected. See "Agency Placement Recommendations" for details. For additional coverage, it is recommended that you install a Smoke Alarm in all rooms, halls, storage areas, finished attics, and basements, where temperatures normally remain between 40° F (4.4° C) and 100° F (37.8° C). Make sure no door or other obstruction could keep smoke from reaching the Smoke Alarms.

#### More specifically, install Smoke Alarms:

- On every level of your home, including finished attics and basements.
- Inside every bedroom, especially if people sleep with the door partly or completely closed.
- In the hall near every sleeping area. If your home has multiple sleeping areas, install a unit in each. If a hall is more than 40 feet long (12 meters), install a unit at each end.
- At the top of the first-to-second floor stairway, and at the bottom of the basement stairway.

### IMPORTANT!

Specific requirements for Smoke Alarm installation vary from state to state and from region to region. Check with your local Fire Department for current requirements in your area. **It is recommended AC or AC/DC units be interconnected for added protection.**

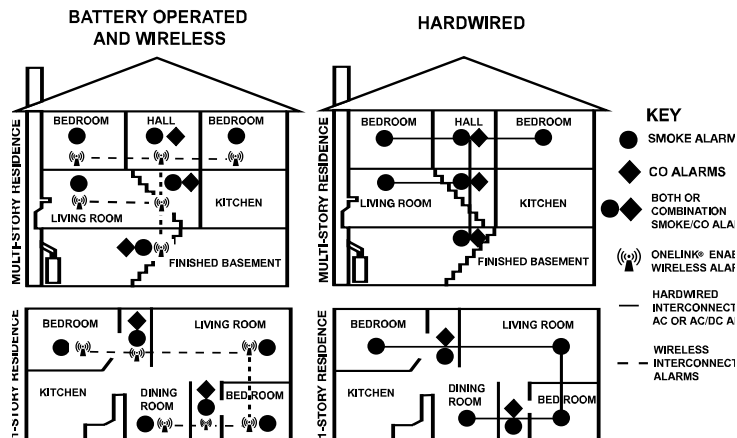

### INSTALLING SMOKE ALARMS IN MOBILE HOMES & RVs

For minimum security install one Smoke Alarm as close to each sleeping area as possible. For more security, put one unit in each room. Many older mobile homes (especially those built before 1978) have little or no insulation. If your mobile home is not well insulated, or if you are unsure of the amount of insulation, it is important to install units on inside walls only. Smoke Alarms should be installed where temperatures normally remain between 40° F (4.4° C) and 100° F (37.8° C).

**WARNING: Test units used in RVs after the vehicle has been in storage, before every trip, and once a week while in use. Failure to test units used in RVs as described may remove your protection.**

### AGENCY PLACEMENT RECOMMENDATIONS

#### NFPA 72 (National Fire Code) Chapter 11

"For your information, the National Fire Protection Association's Standard 72, reads as follows:"

#### "11.5.1 One- and Two-Family Dwelling Units."

**"11.5.1.1 Smoke Detection.** Where required by applicable laws, codes, or standards for the specified occupancy, approved single- and multiple-station Smoke Alarms shall be installed as follows: (1) In all sleeping rooms.

Exception: Smoke Alarms shall not be required in sleeping rooms in existing one- and two-family dwelling units. (2) Outside of each separate sleeping area, in immediate vicinity of the sleeping rooms. (3) On each level of the dwelling unit, including basements. Exception: In existing one- and two family dwelling units, approved Smoke Alarms powered by batteries are permitted."

**"A.11.8.3 Are More Smoke Alarms Desirable?** The required number of Smoke Alarms might not provide reliable early warning protection for those areas separated by a door from the areas protected by the required Smoke Alarms. For this reason, it is recommended that the householder consider the use of additional Smoke Alarms for those areas for increased protection. The additional areas include the basement, bedrooms, dining room, furnace room, utility room, and hallways not protected by the required Smoke Alarms. The installation of Smoke Alarms in kitchens, unfinished attics, or garages is not normally recommended, as these locations occasionally experience conditions that can result in improper operation."

#### California State Fire Marshal (CSFM)

Early warning detection is best achieved by the installation of fire detection equipment in all rooms and areas of the household as follows: A Smoke Alarm installed in each separate sleeping area (in the vicinity, but outside bedrooms), and Heat or Smoke Alarms in the living rooms, dining rooms, bedrooms, kitchens, hallways, finished attics, furnace rooms, closets, utility and storage rooms, basements, and attached garages.

## LOCATIONS TO AVOID FOR SMOKE ALARMS

For best performance, AVOID installing Smoke Alarms in these areas:

- Where combustion particles are produced. Combustion particles form when something burns. Areas to avoid include poorly ventilated kitchens, garages, and furnace rooms. Keep units at least 20 feet (6 meters) from the sources of combustion particles (stove, furnace, water heater, space heater) if possible. In areas where a 20-foot distance is not possible – in modular, mobile, or smaller homes, for example – it is recommended the Smoke Alarm be placed as far from these fuel-burning sources as possible. The placement recommendations are intended to keep these Alarms at a reasonable distance from a fuel-burning source, and thus reduce “unwanted” alarms. Unwanted alarms can occur if a Smoke Alarm is placed directly next to a fuel-burning source. Ventilate these areas as much as possible.
- In air streams near kitchens. Air currents can draw cooking smoke into the sensing chamber of a Smoke Alarm near the kitchen.
- In very damp, humid or steamy areas, or directly near bathrooms with showers. Keep units at least 10 feet (3 meters) away from showers, saunas, dishwashers, etc.
- Where the temperatures are regularly below 40° F (4.4° C) or above 100° F (37.8° C) including unheated buildings, outdoor rooms, porches, or unfinished attics or basements.
- In very dusty, dirty, or greasy areas. Do not install a Smoke Alarm directly over the stove or range. Clean a laundry room unit frequently to keep it free of dust or lint.
- Near fresh air vents, ceiling fans, or in very drafty areas. Drafts can blow smoke away from the unit, preventing it from reaching sensing chamber.
- In insect infested areas. Insects can clog openings to the sensing chamber and cause unwanted alarms.
- Less than 12 inches (305 mm) away from fluorescent lights. Electrical “noise” can interfere with the sensor.
- In “dead air” spaces. “Dead air” spaces may prevent smoke from reaching the Smoke Alarm.

## AVOIDING DEAD AIR SPACES

“Dead air” spaces may prevent smoke from reaching the Smoke Alarm. To avoid dead air spaces, follow the installation recommendations below.

**On ceilings,** install Smoke Alarms as close to the center of the ceiling as possible. If this is not possible, install the Smoke Alarm at least 4 inches (102 mm) from the wall or corner.

**For wall mounting** (if allowed by building codes), the top edge of Smoke Alarms should be placed between 4 inches (102 mm) and 12 inches (305 mm) from the wall/ceiling line, below typical “dead air” spaces.

**On a peaked, gabled, or cathedral ceiling,** install the first Smoke Alarm within 3 feet (0.9 meters) of the peak of the ceiling, measured horizontally. Additional Smoke Alarms may be required depending on the length, angle, etc. of the ceiling's slope. Refer to NFPA 72 for details on requirements for sloped or peaked ceilings.

## ABOUT SMOKE ALARMS

**Battery (DC) operated Smoke Alarms:** Provide protection even when electricity fails, provided the batteries are fresh and correctly installed. Units are easy to install, and do not require professional installation. They do not, however, provide interconnected functionality.

**AC powered Smoke Alarms:** Can be interconnected so if one unit senses smoke, all units alarm. They do not operate if electricity fails.

**AC with battery (DC) back-up:** will operate if electricity fails, provided the batteries are fresh and correctly installed. AC and AC/DC units must be installed by a qualified electrician.

**Wireless Interconnected Alarms:** Offer the same interconnected functionality as with hardwired alarms, without wires. Units are easy to install and do not require professional installation. They provide protection even when electricity fails, provided the batteries are fresh and correctly installed.

**Smoke Alarms for Solar or Wind Energy users and battery backup power systems:** AC powered Smoke Alarms should only be operated with true or pure sine wave inverters. Operating this Smoke Alarm with most battery-powered UPS (uninterruptible power supply) products or square wave or “quasi sine wave” inverters **will damage the Alarm**. If you are not sure about your inverter or UPS type, please consult with the manufacturer to verify.

**Smoke Alarms for the hearing impaired:** Special purpose Smoke Alarms should be installed for the hearing impaired. They include a visual alarm and an audible alarm horn, and meet the requirements of the Americans With Disabilities Act. These units can be interconnected so if one unit senses smoke, all units alarm.

**Smoke alarms are not to be used with detector guards** unless the combination has been evaluated and found suitable for that purpose.

All these Smoke Alarms are designed to provide early warning of fires if located, installed and cared for as described in the user's manual, and if smoke reaches the Alarm. If you are unsure which type of unit to install, refer to NFPA (National Fire Protection Association) 72 (National Fire Alarm Code) and NFPA 101 (Life Safety Code). National Fire Protection Association, One Batterymarch Park, Quincy, MA 02269-9101. Local building codes may also require specific units in new construction or in different areas of the home.

## SPECIAL COMPLIANCE CONSIDERATIONS

### ▲WARNING!

**This Smoke Alarm alone is not a suitable substitute for complete fire detection systems in places housing many people—like apartment buildings, condominiums, hotels, motels, dormitories, hospitals, long-term health care facilities, nursing homes, day care facilities, or group homes of any kind—even if they were once single-family homes. It is not a suitable substitute for complete fire detection systems in warehouses, industrial facilities, commercial buildings, and special-purpose non-residential buildings which require special fire detection and alarm systems. Depending on the building codes in your area, this Smoke Alarm may be used to provide additional protection in these facilities.**

**The following information applies to all four types of buildings listed below:**

In new construction, most building codes require the use of AC or AC/DC powered Smoke Alarms only. AC, AC/DC, or DC powered Smoke Alarms can be used in existing construction as specified by local building codes. Refer to NFPA 72 (National Fire Alarm Code) and NFPA 101 (Life Safety Code), local building codes, or consult your Fire Department for detailed fire protection requirements in buildings not defined as “households.”

#### 1. Single-Family Residence:

Single family home, townhouse. It is recommended Smoke Alarms be installed on every level of the home, in every bedroom, and in each bedroom hallway.

#### 2. Multi-Family or Mixed Occupant Residence:

Apartment building, condominium. This Smoke Alarm is suitable for use in individual apartments or condos, provided a primary fire detection system already exists to meet fire detection requirements in common areas like lobbies, hallways, or porches. Using this Smoke Alarm in common areas may not provide sufficient warning to all residents or meet local fire protection ordinances/regulations.

#### 3. Institutions:

Hospitals, day care facilities, long-term health care facilities. This Smoke Alarm is suitable for use in individual patient sleeping/resident rooms, provided a primary fire detection system already exists to meet fire detection requirements in common areas like lobbies, hallways, or porches. Using this Smoke Alarm in common areas may not provide sufficient warning to all residents or meet local fire protection ordinances/regulations.

#### 4. Hotels and Motels:

Also boarding houses and dormitories. This Smoke Alarm is suitable for use inside individual sleeping/resident rooms, provided a primary fire detection system already exists to meet fire detection requirements in common areas like lobbies, hallways, or porches. Using this Smoke Alarm in common areas may not provide sufficient warning to all residents or meet local fire protection ordinances/regulations.

## LIMITATIONS OF SMOKE ALARMS

Smoke Alarms have played a key role in reducing deaths resulting from home fires worldwide. However, like any warning device, Smoke Alarms can only work if they are properly located, installed, and maintained, and if smoke reaches the Alarms. They are not foolproof.

**Smoke alarms may not waken all individuals.** Practice the escape plan at least twice a year, making sure that everyone is involved – from kids to grandparents. Allow children to master fire escape planning and practice before holding a fire drill at night when they are sleeping. If children or others do not readily waken to the sound of the smoke alarm, or if there are infants or family members with mobility limitations, make sure that someone is assigned to assist them in fire drill and in the event of an emergency. It is recommended that you hold a fire drill while family members are sleeping in order to determine their response to the sound of the smoke alarm while sleeping and to determine whether they may need assistance in the event of an emergency.

**Smoke Alarms cannot work without power.** Battery operated units cannot work if the batteries are missing, disconnected or dead, if the wrong type of batteries are used, or if the batteries are not installed correctly. AC units cannot work if the AC power is cut off for any reason (open fuse or circuit breaker, failure along a power line or at a power station, electrical fire that burns the electrical wires, etc.). If you are concerned about the limitations of battery or AC power, install both types of units.

**Smoke Alarms cannot detect fires if the smoke does not reach the Alarms.** Smoke from fires in chimneys or walls, on roofs, or on the other side of closed doors may not reach the sensing chamber and set off the Alarm. That is why one unit should be installed inside each bedroom or sleeping area—especially if bedroom or sleeping area doors are closed at night—and in the hallway between them.

**Smoke alarms are not to be used with detector guards** unless the combination has been evaluated and found suitable for that purpose.

All these Smoke Alarms are designed to provide early warning of fires if located, installed and cared for as described in the user's manual, and if smoke reaches the Alarm. If you are unsure which type of unit to install, refer to NFPA (National Fire Protection Association) 72 (National Fire Alarm Code) and NFPA 101 (Life Safety Code). National Fire Protection Association, One Batterymarch Park, Quincy, MA 02269-9101. Local building codes may also require specific units in new construction or in different areas of the home.

## **SPECIAL COMPLIANCE CONSIDERATIONS**

### **▲WARNING!**

**This Smoke Alarm alone is not a suitable substitute for complete fire detection systems in places housing many people—like apartment buildings, condominiums, hotels, motels, dormitories, hospitals, long-term health care facilities, nursing homes, day care facilities, or group homes of any kind—even if they were once single-family homes. It is not a suitable substitute for complete fire detection systems in warehouses, industrial facilities, commercial buildings, and special-purpose non-residential buildings which require special fire detection and alarm systems. Depending on the building codes in your area, this Smoke Alarm may be used to provide additional protection in these facilities.**

**The following information applies to all four types of buildings listed below:**

In new construction, most building codes require the use of AC or AC/DC powered Smoke Alarms only. AC, AC/DC, or DC powered Smoke Alarms can be used in existing construction as specified by local building codes. Refer to NFPA 72 (National Fire Alarm Code) and NFPA 101 (Life Safety Code), local building codes, or consult your Fire Department for detailed fire protection requirements in buildings not defined as "households."

#### **1. Single-Family Residence:**

Single family home, townhouse. It is recommended Smoke Alarms be installed on every level of the home, in every bedroom, and in each bedroom hallway.

#### **2. Multi-Family or Mixed Occupant Residence:**

Apartment building, condominium. This Smoke Alarm is suitable for use in individual apartments or condos, provided a primary fire detection system already exists to meet fire detection requirements in common areas like lobbies, hallways, or porches. Using this Smoke Alarm in common areas may not provide sufficient warning to all residents or meet local fire protection ordinances/regulations.

#### **3. Institutions:**

Hospitals, day care facilities, long-term health care facilities. This Smoke Alarm is suitable for use in individual patient sleeping/resident rooms, provided a primary fire detection system already exists to meet fire detection requirements in common areas like lobbies, hallways, or porches. Using this Smoke Alarm in common areas may not provide sufficient warning to all residents or meet local fire protection ordinances/regulations.

#### **4. Hotels and Motels:**

Also boarding houses and dormitories. This Smoke Alarm is suitable for use inside individual sleeping/resident rooms, provided a primary fire detection system already exists to meet fire detection requirements in common areas like lobbies, hallways, or porches. Using this Smoke Alarm in common areas may not provide sufficient warning to all residents or meet local fire protection ordinances/regulations.

## **LIMITATIONS OF SMOKE ALARMS**

Smoke Alarms have played a key role in reducing deaths resulting from home fires worldwide. However, like any warning device, Smoke Alarms can only work if they are properly located, installed, and maintained, and if smoke reaches the Alarms. They are not foolproof.

**Smoke alarms may not waken all individuals.** Practice the escape plan at least twice a year, making sure that everyone is involved – from kids to grandparents. Allow children to master fire escape planning and practice before holding a fire drill at night when they are sleeping. If children or others do not readily waken to the sound of the smoke alarm, or if there are infants or family members with mobility limitations, make sure that someone is assigned to assist them in fire drill and in the event of an emergency. It is recommended that you hold a fire drill while family members are sleeping in order to determine their response to the sound of the smoke alarm while sleeping and to determine whether they may need assistance in the event of an emergency.

**Smoke Alarms cannot work without power.** Battery operated units cannot work if the batteries are missing, disconnected or dead, if the wrong type of batteries are used, or if the batteries are not installed correctly. AC units cannot work if the AC power is cut off for any reason (open fuse or circuit breaker, failure along a power line or at a power station, electrical fire that burns the electrical wires, etc.). If you are concerned about the limitations of battery or AC power, install both types of units.

**Smoke Alarms cannot detect fires if the smoke does not reach the Alarms.** Smoke from fires in chimneys or walls, on roofs, or on the other side of closed doors may not reach the sensing chamber and set off the Alarm. That is why one unit should be installed inside each bedroom or sleeping area—especially if bedroom or sleeping area doors are closed at night—and in the hallway between them.

**Smoke Alarms may not detect fire on another floor or area of the dwelling.** For example, a stand-alone unit on the second floor may not detect smoke from a basement fire until the fire spreads. This may not give you enough time to escape safely. That is why recommended minimum protection is at least one unit in every sleeping area, and every bedroom on every level of your dwelling. Even with a unit on every floor, stand-alone units may not provide as much protection as interconnected units, especially if the fire starts in a remote area. Some safety experts recommend installing interconnected AC powered units with battery back-up (see "About Smoke Alarms") or professional fire detection systems, so if one unit senses smoke, all units alarm. Interconnected units may provide earlier warning than stand-alone units since all units alarm when one detects smoke.

**Smoke Alarms may not be heard.** Though the alarm horn in this unit meets or exceeds current standards, it may not be heard if: 1) the unit is located outside a closed or partially closed door, 2) residents recently consumed alcohol or drugs, 3) the Alarm is drowned out by noise from stereo, TV, traffic, air conditioner or other appliances, 4) residents are hearing impaired or sound sleepers. Special purpose units, like those with visual and audible alarms, should be installed for hearing impaired residents.

**Smoke Alarms may not have time to alarm before the fire itself causes damage, injury, or death, since smoke from some fires may not reach the unit immediately. Examples of this include persons smoking in bed, children playing with matches, or fires caused by violent explosions resulting from escaping gas.**

**Smoke Alarms are not foolproof.** Like any electronic device, Smoke Alarms are made of components that can wear out or fail at any time. You must test the unit weekly to ensure your continued protection. Smoke Alarms cannot prevent or extinguish fires. They are not a substitute for property or life insurance.

**Smoke Alarms have a limited life.** The unit should be replaced immediately if it is not operating properly. You should always replace a Smoke Alarm after 10 years from date of purchase. Write the purchase date on the space provided on back of unit.

## **LIMITED WARRANTY**

BRK Brands, Inc., ("BRK") the maker of First Alert® brand and BRK® brand products, warrants that for a period of ten years from the date of purchase, this product will be free from defects in material and workmanship. BRK, at its option, will repair or replace this product or any component of the product found to be defective during the warranty period. Replacement will be made with a new or remanufactured product or component. If the product is no longer available, replacement may be made with a similar product of equal or greater value. This is your exclusive warranty.

This warranty is valid for the original retail purchaser from the date of initial retail purchase and is not transferable. Keep the original sales receipt. Proof of purchase is required to obtain warranty performance. BRK dealers, service centers, or retail stores selling BRK products do not have the right to alter, modify or any way change the terms and conditions of this warranty.

This warranty does not cover normal wear of parts or damage resulting from any of the following: negligent use or misuse of the product, use on improper voltage or current, use contrary to the operating instructions, disassembly, repair or alteration by anyone other than BRK or an authorized service center. Further, the warranty does not cover Acts of God, such as fire, flood, hurricanes and tornadoes or any batteries that are included with this unit.

BRK shall not be liable for any incidental or consequential damages caused by the breach of any express or implied warranty. Except to the extent prohibited by applicable law, any implied warranty of merchantability or fitness for a particular purpose is limited in duration to the duration of the above warranty. Some states, provinces or jurisdictions do not allow the exclusion or limitation of incidental or consequential damages or limitations on how long an implied warranty lasts, so the above limitations or exclusion may not apply to you. This warranty gives you specific legal rights, and you may also have other rights that vary from state to state or province to province.

### **How to Obtain Warranty Service**

**Service:** If service is required, do not return the product to your retailer. In order to obtain warranty service, contact the Consumer Affairs Division at 1-800-323-9005, 7:30 AM - 5:00 PM Central Standard Time, Monday through Friday. To assist us in serving you, please have the model number and date of purchase available when calling.

### **For Warranty Service return to:**

BRK Brands, Inc., 25 Spur Drive, El Paso, TX 79906

**Battery:** BRK Brands, Inc. make no warranty, express or implied, written or oral, including that of merchantability or fitness for any particular purpose with respect to battery.